

Eclipse ThermJet Burners

Model TJ0015 - 2000

Technical Information Edition 2.14

Version 2

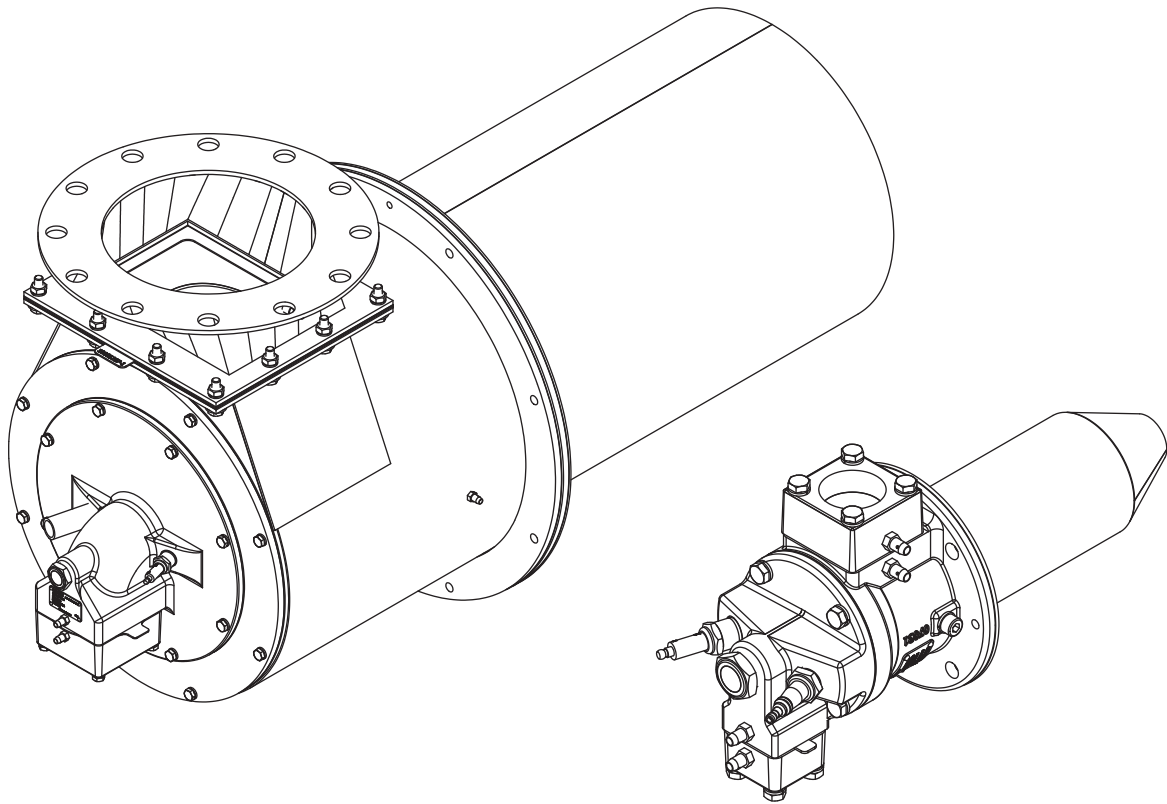

Copyright

Copyright 2007 by Eclipse, inc. All rights reserved worldwide. This publication is protected by federal regulation and shall not be copied, distributed, transmitted, transcribed or translated into any human or computer language, in any form or by any means, to any third parties, without the express written consent of Eclipse, inc.

Disclaimer Notice

In accordance with the manufacturer’s policy of continual product improvement, the product presented in this brochure is subject to change without notice or obligation.

The material in this manual is believed adequate for the intended use of the product. If the product is used for purposes other than those specified herein, confirmation of validity and suitability must be obtained. Eclipse warrants that the product itself does not infringe upon any United States patents. No further warranty is expressed or implied.

Liability & Warranty

We have made every effort to make this manual as accurate and complete as possible. Should you find errors or omissions, please bring them to our attention so that we may correct them. In this way we hope to improve our product documentation for the benefit of our customers. Please send your corrections and comments to our Technical Documentation Specialist.

It must be understood that Eclipse’s liability for its product, whether due to breach of warranty, negligence, strict liability, or otherwise is limited to the furnishing of replacement parts and Eclipse will not be liable for any other injury, loss, damage or expenses, whether direct or consequential, including but not limited to loss of use,

income, or damage to material arising in connection with the sale, installation, use of, inability to use, or the repair or replacement of Eclipse’s products.

Any operation expressly prohibited in this manual, any adjustment, or assembly procedures not recommended or authorized in these instructions shall void the warranty.

Document Conventions

There are several special symbols in this document. You must know their meaning and importance.

The explanation of these symbols follows below. Please read it thoroughly.

How To Get Help

If you need help, contact your local Eclipse representative. You can also contact Eclipse at:

1665 Elmwood Rd.
 Rockford, Illinois 61103 U.S.A.
 Phone: 815-877-3031
 Fax: 815-877-3336
<http://www.eclipsenet.com>

Please have the information on the product label available when contacting the factory so we may better serve you.

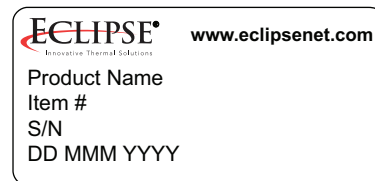

This is the safety alert symbol. It is used to alert you to potential personal injunt hazards. Obey all safety messages that follow this symbol to avoid possible injury or death.



Indicates a hazardous situation which, if not avoided, will result in death or serious injury.



Indicates a hazardous situation which, if not avoided, could result in death or serious injury.



Indicates a hazardous situation which, if not avoided, could result in minor or moderate injury.

NOTICE

Is used to address practices not related to personal injury.

NOTE

Indicates an important part of text. Read thoroughly.



Table of Contents

1 Introduction	4
Product Description	4
Audience	4
Purpose	4
ThermJet Documents	4
Related Documents.....	4
2 Safety	5
Safety Warnings	5
Capabilities.....	5
Operator Training	5
Replacement Parts.....	5
3 System Design	6
Design	6
Step 1: Burner Model Selection.....	6
Step 2: Control Methodology.....	7
Step 3: Ignition System	12
Step 4: Flame Monitoring Control System.....	14
Step 5: Combustion Air System (Blower and Air Pressure Switch).....	14
Step 6: Main Gas Shut-Off Valve Train	16
Step 7: Process Temperature Control System.....	16
Appendix	i
System Schematics	ii
Notes	iv

Introduction

1

Product Description

The ThermJet is a nozzle-mix burner that is designed to fire an intense stream of hot gases through a combustor using ambient combustion air.

The high velocity of the gases improves temperature uniformity product quality and system efficiency.

The ThermJet Burner comes in two types:

- High Velocity (HV)
- Medium Velocity (MV)

Flame velocity information is available in Datasheets 205-1 through 205-13.

The gas velocity can be as high as 500 ft/s for the High Velocity burner, and 250 ft/s for the Medium Velocity burner.

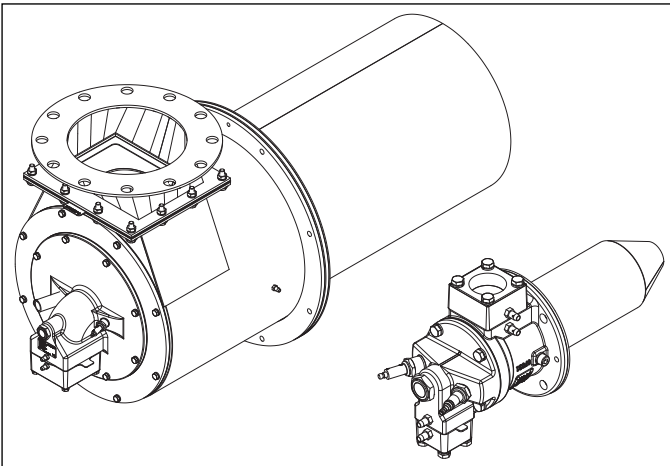

Figure 1.1. Eclipse ThermJet Burner

Audience

This manual has been written for people who are already familiar with all aspects of a nozzle-mix burner and its add-on components, also referred to as “the burner system”.

These aspects are:

- Design/Selection
- Use
- Maintenance

The audience is expected to have previous experience with this type of equipment.

Purpose

The purpose of this manual is to make sure that you carry out the installation of a safe, effective, and trouble-free system.

ThermJet Documents

Design Guide No. 205

- This document

Datasheet No. 205-1 through 205-13

- Available for individual TJ models
- Required to complete design calculations in this guide

Installation Guide No. 205

- Used with Datasheets to complete installation

Related Documents

- EFE 825 (Combustion Engineering Guide)
- Eclipse Bulletins and Information Guides: 610, 710, 720, 730, 742, 744, 760, 930

Safety

2

Important notices which help provide safe burner operation will be found in this section. To avoid personal injury and damage to the property or facility, the following warnings must be observed. All involved personnel should read this entire manual carefully before attempting to start or operate this system. If any part of the information in this manual is not understood, contact Eclipse before continuing.

Safety Warnings



DANGER

- **The burners, described herein, are designed to mix fuel with air and burn the resulting mixture. All fuel burning devices are capable of producing fires and explosions if improperly applied, installed, adjusted, controlled or maintained.**
- **Do not bypass any safety feature; fire or explosion could result.**
- **Never try to light a burner if it shows signs of damage or malfunction.**



WARNING

- **The burner and duct sections are likely to have HOT surfaces. Always wear the appropriate protective equipment when approaching the burner.**
- **Eclipse products are designed to minimize the use of materials that contain crystalline silica. Examples of these chemicals are: respirable crystalline silica from bricks, cement or other masonry products and respirable refractory ceramic fibers from insulating blankets, boards, or gaskets. Despite these efforts, dust created by sanding, sawing, grinding, cutting and other construction activities could release crystalline silica. Crystalline silica is known to cause cancer, and health risks from the exposure to these chemicals vary depending on the frequency and length of exposure to these chemicals. To reduce the risk, limit exposure to these chemicals, work in a well-ventilated area and wear approved personal protective safety equipment for these chemicals.**

NOTICE

- **This manual provides information regarding the use of these burners for their specific design purpose. Do not deviate from any instructions or application limits described herein without written approval from Eclipse.**

Capabilities

Only qualified personnel, with sufficient mechanical aptitude and experience with combustion equipment, should adjust, maintain or troubleshoot any mechanical or electrical part of this system. Contact Eclipse for any needed commissioning assistance.

Operator Training

The best safety precaution is an alert and trained operator. Train new operators thoroughly and have them demonstrate an adequate understanding of the equipment and its operation. A regular retraining schedule should be administered to ensure operators maintain a high degree of proficiency. Contact Eclipse for any needed site-specific training.

Replacement Parts

Order replacement parts from Eclipse only. All Eclipse approved valves or switches should carry UL, FM, CSA, CGA and/or CE approval where applicable.

System Design

3

Design

Designing a burner system is a straight-forward exercise of combining modules that add up to a reliable and safe system.

The design process is divided into the following steps:

1. Burner model selection:
2. Control Methodology
3. Ignition System
4. Flame Monitoring System
5. Combustion Air System
6. Main gas shut-off valve train selection
7. Process temperature control system

Step 1: Burner Model Selection

Burner Size and Quantity

Select the size and number of burners based on the heat balance. For heat balance calculations, refer to the Combustion Engineering Guide (EFE 825).

Use the ThermJet Price List 205 and Datasheet series 205 for performance data, dimensions, and specifications.

Flame Velocity

Each burner size comes in two versions, High or Medium Velocity. Select the version needed based on requirements for temperature uniformity, circulation, chamber size, air pressure and overall operating costs.

Flame velocity information is available in Datasheets 205-1 through 205-13.

Fuel Type

Table 3.1 Fuel Type

Fuel	Symbol	Gross Heating Value	Specific Gravity	WOBBE Index
Natural Gas	CH ₄ 90%+	1000 Btu/ft ³ (40.1 MJ/m ³)	0.60	1290 Btu/ft ³
Propane	C ₃ H ₈	2525 Btu/ft ³ (101.2 MJ/m ³)	1.55	2028 Btu/ft ³
Butane	C ₄ H ₁₀	3330 Btu/ft ³ (133.7 MJ/m ³)	2.09	2303 Btu/ft ³
Btu/ft ³ @ standard conditions (MJ/m ³ @ normal conditions)				

If using an alternative fuel supply, contact Eclipse with an accurate breakdown of the fuel components.

Fuel Pressure

The gas pressure must be at the minimum level shown.

The required gas pressure at the burner can be found in ThermJet Datasheets 205-1 through 205-13.

Combustor Type

The combustor that you choose depends on the temperature and the construction of the furnace.

The furnace temperature limits of the combustors can be found in ThermJet Datasheets 205-1 through 205-13.



CAUTION

- For tangential firing furnaces, do not use alloy combustors.

Step 2: Control Methodology

NOTICE

- **If the burner is shut off during operation at temperatures above 1000°F (538°C), provisions must be made to provide an adequate amount of flowing combustion air to keep the burner internal components cool.**

The control methodology is the basis for the rest of the design process. Once it is known what the system will look like, the components that are in it can be selected. The control methodology chosen depends on the type of process to be controlled.

NOTE: The stated operational characteristics only apply if the described control circuits are followed. Use of different control methods will result in unknown operational performance characteristics. Use the control circuits contained within this section or contact Eclipse for written, approved alternatives.

There are two main methods to control the input of a ThermJet system. Each of these methods also has two variants. These methods may be applied to single burner as well as multiple burner systems.

The methods and variants are:

1. Modulating control:
 - a. Modulating gas & air, on-ratio control or excess air @ low fire on page 8.
 - b. Modulating gas with fixed-air control on page 9.
2. High/low control:
 - a. High/low air & gas control (pulse firing) on page 10.
 - b. High/low gas with fixed-air control (Can also be used for pulse firing) on page 11.

NOTE: Use of a ratio regulator in a fixed-air system is optional. However, eliminating the ratio regulator will adversely affect the ignition reliability at inputs greater than 40% of maximum.

Use of a ratio regulator in a fixed-air system also provides automatic gas modulation if system air flow changes over time (such as a clogged air filter).

In the pages that follow you will find schematics of these control methods. The symbols in the schematics are explained in the "Key to System Schematics" (see Appendix).

Automatic Gas Shut-Off by Burner or Shut-Off by Zone

The automatic gas shut-off valve can be installed in two operational modes:

1. Automatic Gas Shut-Off by Burner

If the flame monitoring system detects a failure, the gas shut-off valves close the gas supply to the burner that caused the failure.

2. Automatic Gas Shut-Off by Zone

If the flame monitoring system detects a failure, the gas shut-off valves close the gas supply to all the burners in the zone that caused the failure.

NOTE: All ThermJet control schematics on the following pages reflect a single gas automatic shut-off valve. This may be changed to conform to local safety and/or insurance requirements. (Refer to the ThermJet Installation Guide No. 205).

Modulating Gas & Air

On-ratio Control or Excess Air @ Low Fire (Figure 3.1)

A burner system with modulating control gives an input that is in proportion with the demands of the process. ANY input between high and low fire is possible.

1. Air:

The control valve **1** is in the air line. It can modulate air flow to any position between low and high fire air.

2. Gas:

The ratio regulator **2** allows the on-ratio amount of gas to go to the burner. Low fire gas is limited by the ratio regulator **2**. High fire gas is limited by the manual butterfly valve **3**.

NOTE: The ratio regulator can be biased to give excess air at low fire.

NOTE: Do not use an adjustable limiting orifice (ALO) as the high fire gas limiting valve **3**. ALO's require too much pressure drop for use in a proportional system.

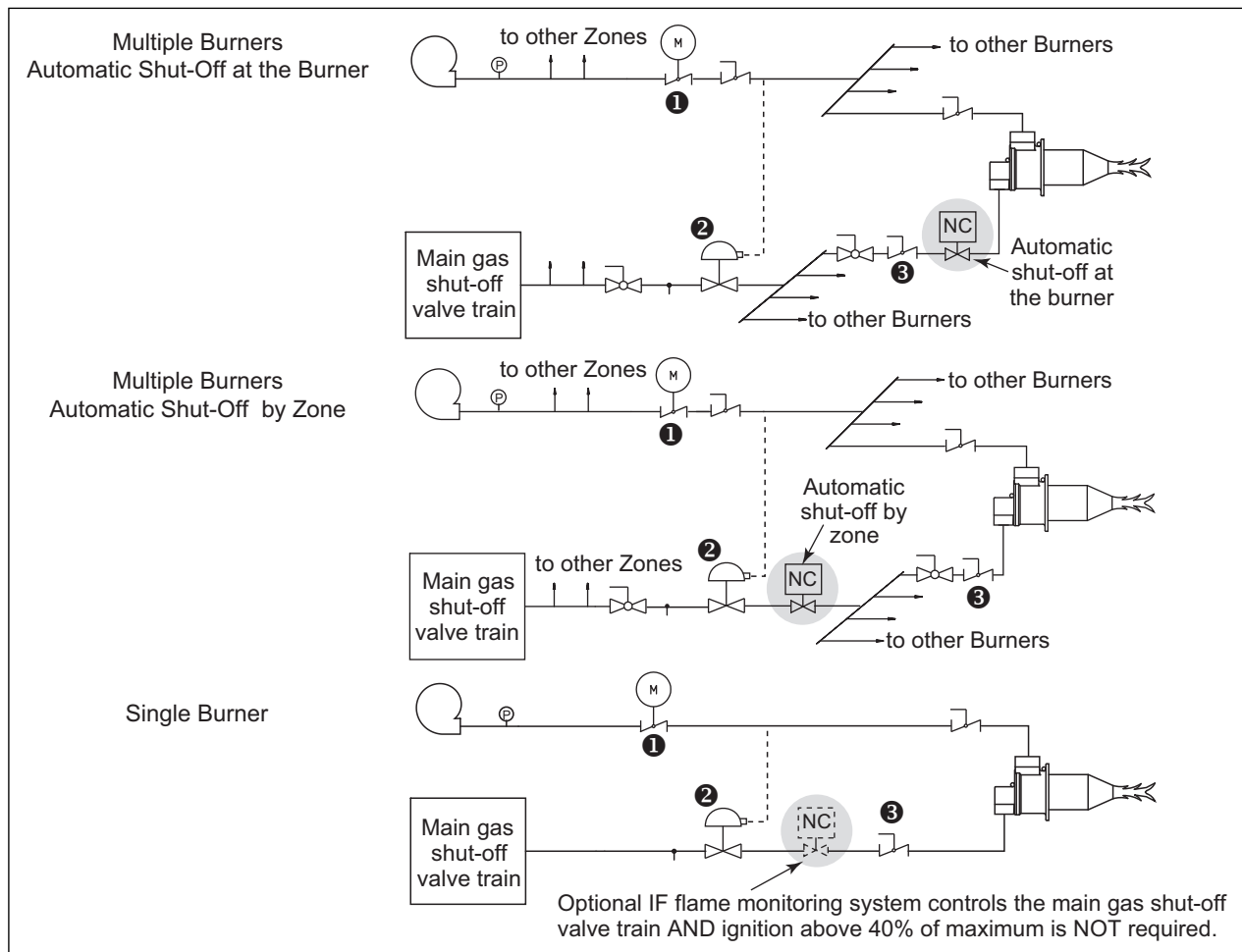

Figure 3.1 Modulating Gas & Air (On-Ratio Control or Excess Air @ Low Fire)

Modulating Gas with Fixed-Air Control (Figure 3.2)

A burner system with modulating control gives an input that is in proportion with the demands of the process. ANY input between high and low fire is possible.

NOTE: Use of a ratio regulator ❷ in a fixed-air system is optional on a single burner system only. However, eliminating the ratio regulator will adversely affect the ignition reliability at inputs greater than 40% of maximum.

1. Air:

The amount of air to the burner is fixed.

2. Gas:

The control valve ❶ is in the gas line. It can modulate to any position between low and high fire.

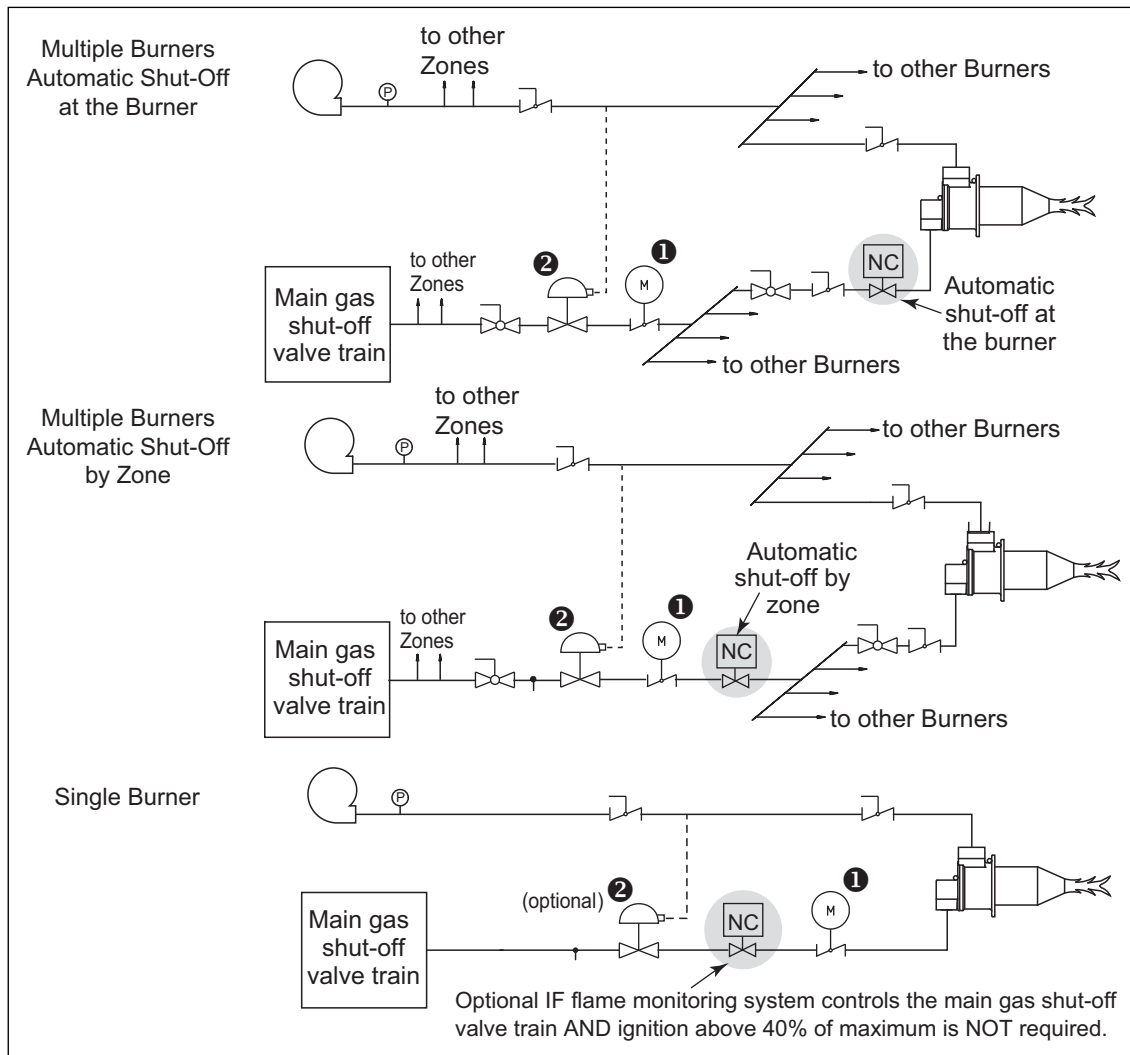

Figure 3.2 Modulating Gas with Fixed-Air Control

High/Low Air & Gas Control (Pulse Firing) (Figure 3.3)

A burner system with high/low control gives a high or low fire input to the process. No input between high and low fire is possible.

1. Air:

- a. Low fire: A control input closes the solenoid valve ④. As a result the CRS valve ⑤ quickly moves to low fire.

2. Gas:

- b. High fire: A control input opens the solenoid valve ④. As a result the CRS valve ⑤ quickly moves to high fire.
- a. Low fire: A control input closes the solenoid valve ①. Low fire gas passes through the butterfly valve ③.
- b. High fire: A control input opens the solenoid valve ①.

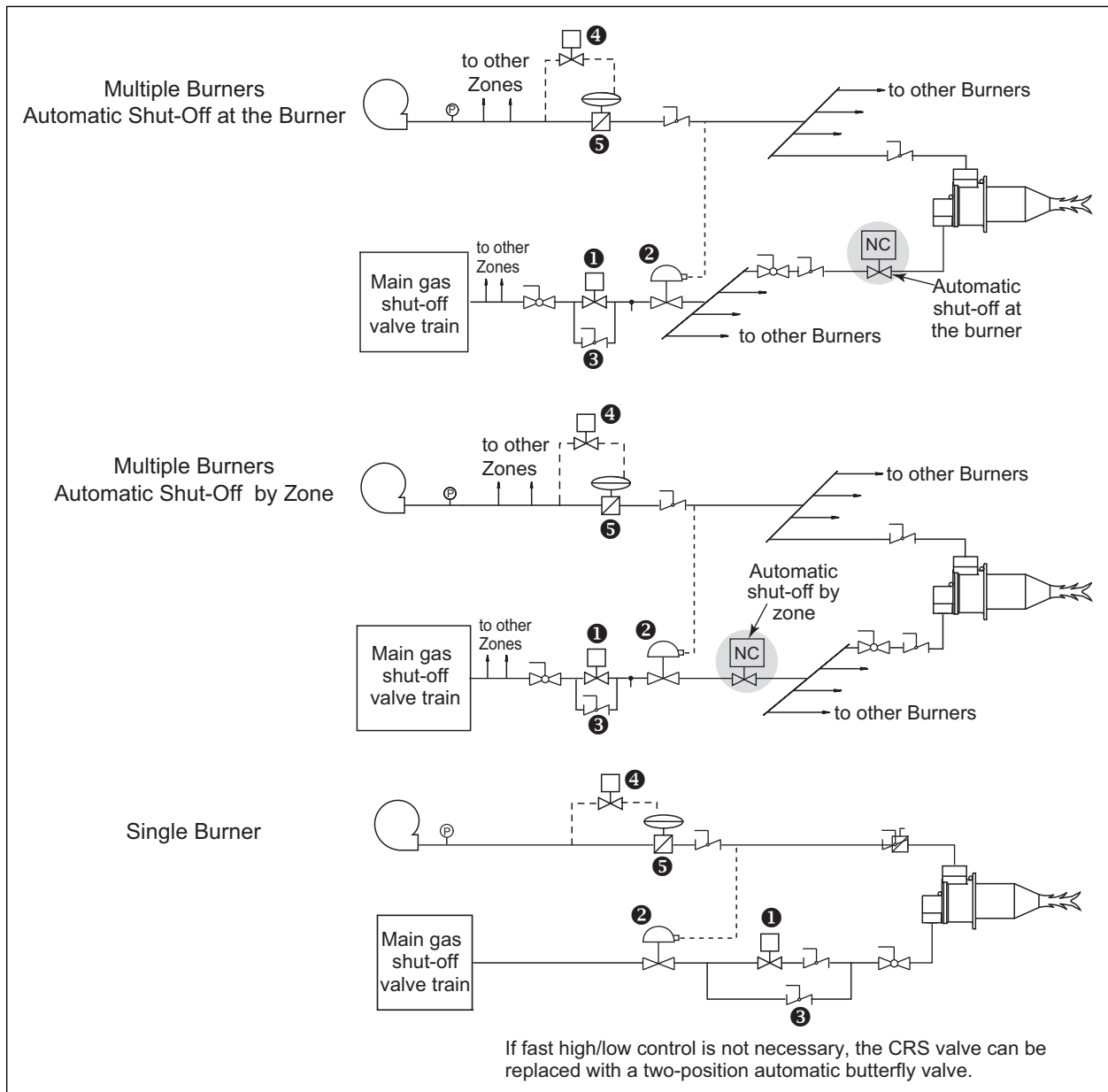

Figure 3.3 High/Low Air & Gas Control (Pulse Firing)

High/Low Gas with Fixed-Air Control

(Can also be used for pulse firing.)

A burner system with high/low control gives a high or a low input to the process. NO input between high and low fire is possible.

1. Air:

The amount of air to the burner is fixed.

2. Gas:

- a. Low fire: A control input closes the solenoid valve
 - ①. Low fire gas passes through the butterfly valve
 - ③.
- b. High fire: A control input opens the solenoid valve
 - ①. High fire gas passes through the open solenoid valve
 - valve ①.

NOTE: Use of a ratio regulator ② in a fixed-air system is optional on a single burner system only. However, eliminating the ratio regulator will adversely affect the ignition reliability at inputs greater than 40% of maximum.

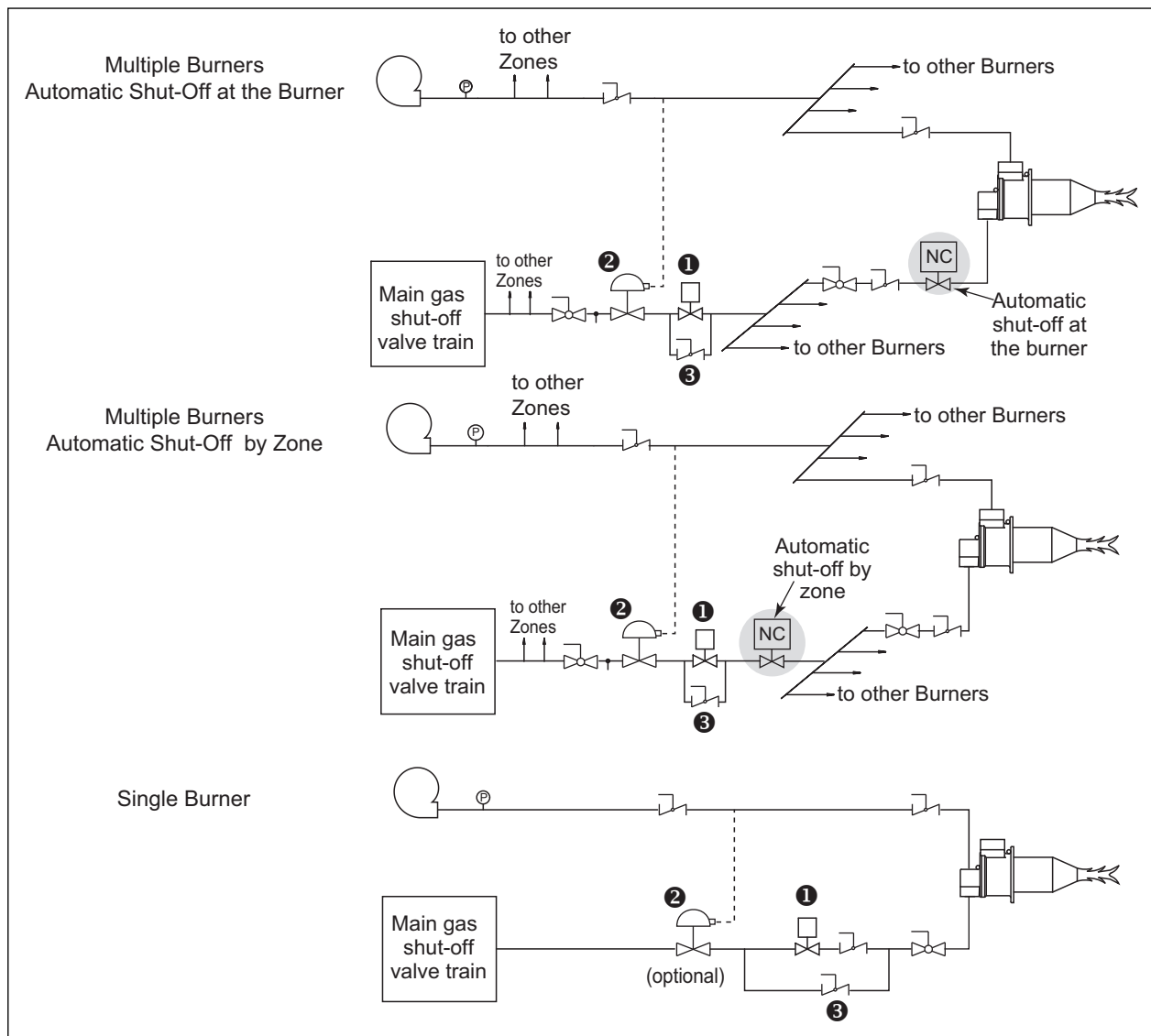

Figure 3.4 High/Low Gas with Fixed-Air Control

Step 3: Ignition System

For the ignition system use:

- 6,000 VAC transformer
- Full-wave spark transformer
- One transformer per burner

DO NOT USE:

- 10,000 VAC transformer
- Twin outlet transformer
- Distributor type transformer
- Half-wave transformer

It is recommended that low fire start be used, however, ThermJet burners are capable of direct spark ignition anywhere within the specified ignition zone (see Datasheets 205-1 through 205-13).

NOTE: You must follow the control circuits described in the previous section, “Control Methodology,” to obtain reliable ignition.

Local safety and insurance require limits on the maximum trial for ignition time. These time limits vary from country to country.

The time it takes for a burner to ignite depends on:

- The distance between the gas shut-off valve and the burner.
- The air/gas ratio.
- The gas flow at start conditions.

It is possible to have the low fire too low to ignite within the trial for ignition period. Under these circumstances you must consider the following options:

- Start at higher input levels.
- Resize and/or relocate the gas controls.
- Use bypass start gas. (See the circuit schematics on the next page.)

Bypass Start Gas (Optional) (Figure 3.5)

A bypass start gas circuit provides gas flow around zone gas control valves during the trial for ignition period. This should only be used if excess air (proportional or fixed air control) is being used on low fire; it should NOT be used with on-ratio low fire systems.

During the trial for ignition period, the solenoid valve in the bypass line plus the automatic gas shut-off valve (either at each burner or each zone) are opened. If a flame is established, the bypass solenoid valve closes at the end of the trial for ignition period. If a flame is not established, then the bypass solenoid valve and the automatic gas shut-off valve close.

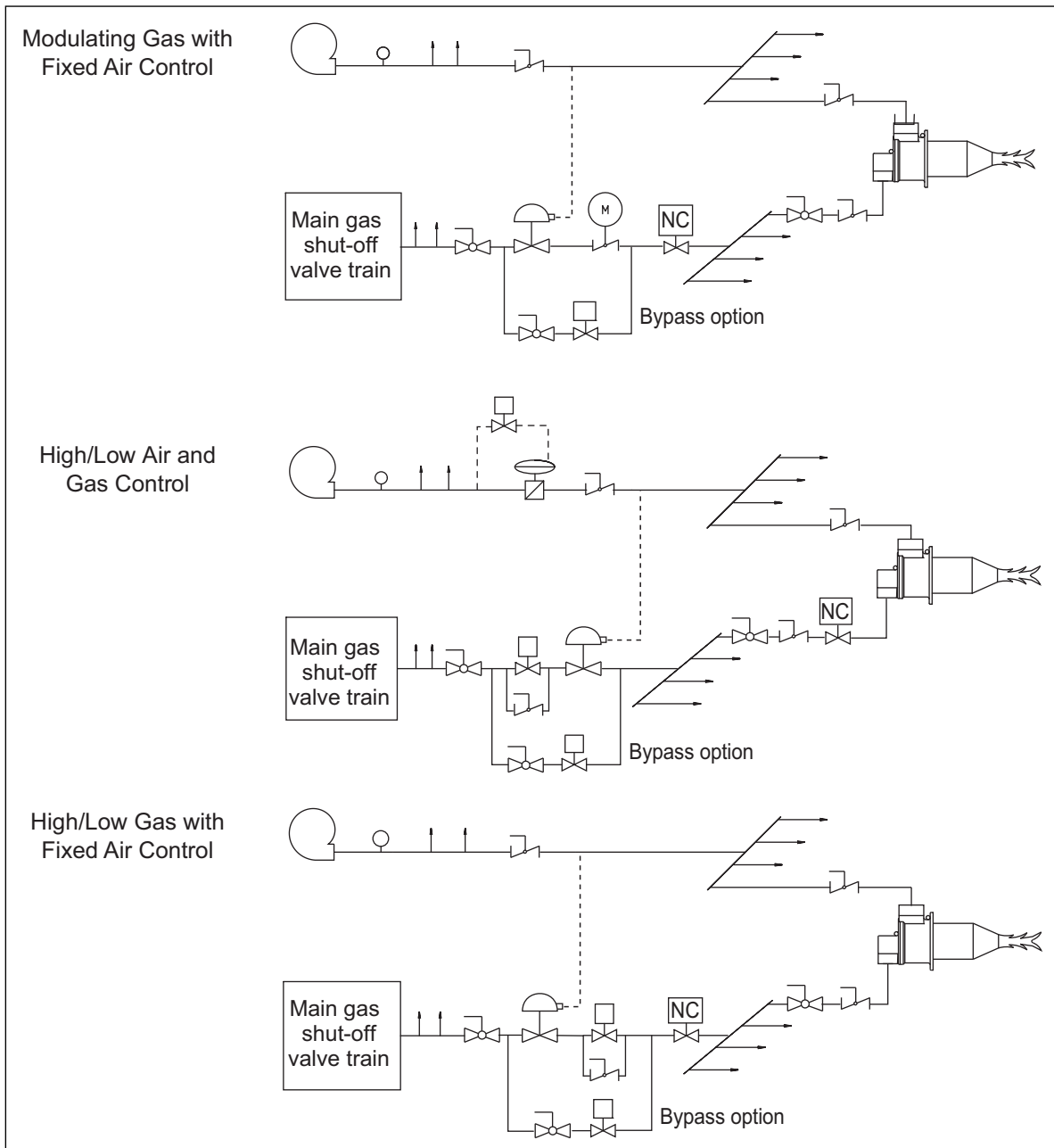

Figure 3.5 Bypass Start Gas Circuit Schematics

Step 4: Flame Monitoring System

A flame monitoring system consists of two main parts:

- A flame sensor
- Flame monitoring control

Flame Sensor

There are two types that you can use for a ThermJet burner:

- UV scanner
- Flame rod

A UV scanner can be used with all combustor types.

The UV scanner must be compatible to the flame monitoring control that is used. Refer to the manual of your selected control for proper selection of the scanner.

NOTE: Flame rod option is not available for the TJ300 and larger.

- The standard flame rod is used with natural gas, propane, butane and pre-heated air up to 300°F.

You can find more information in Info Guide 832.

Flame Monitoring Control

The flame monitoring control is the equipment that processes the signal from the flame rod or the UV scanner.

For flame monitoring control you may select several options:

- Flame monitoring control for each burner: if one burner goes down, only that burner will be shut off
- Multiple-burner flame monitoring control: if one burner goes down, all burners will be shut off

Eclipse recommends the following:

- Trilogy series T600; see Instruction Manual 835
- Bi-flame series; see instruction manual 826
- Multi-flame series 6000; see Instruction Manual 820
- Veri-flame; see Instruction Manual 818

If other controls are considered, contact Eclipse to determine how burner performance may be affected. Flame monitoring controls that have lower sensitivity flame detecting circuits may limit burner turndown and change the requirements for ignition. Flame monitoring controls that stop the spark as soon as a signal is detected may prevent establishment of flame, particularly when using UV scanners. The flame monitoring control must maintain the spark for a fixed time interval that is long enough for ignition.

DO NOT USE the following:

- Flame monitoring relays which interrupt the trial for ignition when the flame is detected
- Flame sensors which supply a weak signal
- Flame monitoring relays with low sensitivity



WARNING

- **A UV scanner can possibly detect another burner's flame if it is in the line of sight, and falsely indicate flame presence. Use a flame rod in this situation. This helps prevent accumulation of unburned fuel which, in extreme situations, could cause a fire or an explosion.**

Step 5: Combustion Air System (Blower & Air Pressure Switch)

Effects of Atmospheric Conditions

The blower data is based on the International Standard Atmosphere (ISA) at Mean Sea Level (MSL), which means that it is valid for:

- Sea level
- 29.92" Hg (1,013 mbar)
- 70°F (21°C)

The makeup of the air is different above sea level or in a hot area. The density of the air decreases, and as a result, the outlet pressure and the flow of the blower decrease. An accurate description of these effects is in the Eclipse Combustion Engineering Guide (EFE 825). The Guide contains tables to calculate the effect of pressure, altitude and temperature on air.

Blower

The rating of the blower must match the system requirements. You can find all the blower data in: Bulletin/Info Guide 610.

Follow these steps:

1. Calculate the outlet pressure.

When calculating the outlet pressure of the blower, the total of these pressures must be calculated.

- The static air pressure required at the burner
- The total pressure drop in the piping
- The total of the pressure drops across the valves
- The pressure in the chamber (suction or pressurized)
- Recommend a minimum safety margin of 10%

2. Calculate the required flow:

The blower output is the air flow delivered under standard atmospheric conditions. It must be enough to feed all the burners in the system at high fire.

Combustion air blowers are normally rated in terms of standard cubic feet per hour (SCFH) of air. An example calculation follows the informations tables below:

Table 3.2 Required Calculation Information

Description	Unit of Measure	Formula Symbol
Number of burners	-	-
Type of fuel	-	-
Gross heating value of fuel	Btu/ft ³ (MJ/m ³)	q
Desired excess air percentage (Typical excess air percentage @ high fire is 15%)	percent	%
Air/Gas ratio (Fuel specific, see table below)	-	α
Air flow	scfh (Nm ³ /hr)	V _{air}
Gas flow	scfh (Nm ³ /hr)	V _{gas}

Table 3.3 Fuel Gas Heating Values

Fuel Gas	Stoichiometric* Air/Gas Ratio α(ft ³ _{air} /ft ³ _{gas})	Gross Heating Value q (Btu/ft ³)
Natural Gas (Birmingham, AL)	9.41	1,002 (40 MJ/m ³)
Propane	23.82	2,564 (102,5 MJ/m ³)
Butane	30.47	3,333(133,3 MJ/m ³)

*Stoichiometric: No excess air. The precise amount of air and gas are present for complete combustion.

Example Blower Calculation

A batch furnace requires a gross heat input of 2,900,000 Btu/hr (based on 45% efficiency). The designer decides to provide the required heat input with four burners operating on natural gas using 15% excess air.

Calculation Example:

- a. Decide which ThermJet burner model is appropriate:

$$\frac{Q \text{ (total heat input) of } 2,900,000 \text{ BTU/hr}}{4 \text{ burners}} = \frac{725,000}{\text{BTU/hr/burner}}$$

- Select 4 model TJ0075 ThermJet burners based on the required heat input of 725,000 Btu/hr for each burner.

- b. Calculate required gas flow:

$$V_{\text{gas}} = \frac{Q}{q} = \frac{2,900,000 \text{ BTU/hr}}{1,002 \text{ BTU/ft}^3} = 2,894 \text{ ft}^3/\text{hr}$$

- Gas flow of 2,894 ft³/hr is required.

- c. Calculate required stoichiometric air flow:

$$V_{\text{air-stoichiometric}} = \alpha \text{ (air/gas ratio)} \times V_{\text{gas}}$$

$$= 9.41 \times 2,894 \text{ ft}^3/\text{hr} = 27,235 \text{ ft}^3/\text{hr}$$

- Stiochiometric air flow of 27,235 SCFH required.

- d. Calculate final blower air flow requirement based on the desired amount of excess air:

$$V_{\text{air}} = (1 + \text{excess air}\%) \times V_{\text{air-stoichiometric}}$$

$$= (1 + 0.15) \times 27,235 \text{ ft}^3/\text{hr} = 31,320 \text{ ft}^3/\text{hr}$$

- For this example, final blower air flow requirement is 31,320 SCFH at 15% excess air.

NOTE: It is common practice to add an additional 10% to the final blower air flow requirement as a safety margin.

- 3. Find the blower model number and motor horsepower (hp). With the output pressure and the specific flow, you can find the blower catalog number and the motor hp in Bulletin 610.
- 4. Eclipse recommends that you select a totally enclosed fan cooled (TEFC) motor.
- 5. Select the other parameters:
 - inlet filter or inlet grille
 - Inlet size (frame size)
 - voltage, number of phases, frequency
 - blower outlet location, and rotation direction clockwise (CW) or counter-clockwise (CCW).

NOTE: The use of an inlet air filter is strongly recommended. The system will perform longer and the settings will be more stable.

NOTE: When selecting a 60 Hz Blower for use on 50 Hz, a pressure and capacity calculation is required. See Eclipse Engineering Guide (EFE 825).

The total selection information you should now have:

- blower model number
- motor hp
- motor enclosure (TEFC)
- voltage, number of phases, frequency
- outlet position and rotation direction (CW or CCW)

Air Pressure Switch

The air pressure switch gives a signal to the monitoring system when there is not enough air pressure from the blower. You can find more information on pressure switches in Blower Bulletin 610.



- Eclipse supports NFPA and EN regulations, which require the use of an air pressure switch in conjunction with other safety components, as a minimum standard for main gas safety shut-off systems.

Step 6: Main Gas Shut-Off Valve Train

Consult Eclipse

Eclipse can help you design and obtain a main gas shut-off valve train that complies with the current safety standards.

The shut-off valve train must comply with all the local safety standards set by the authorities that have jurisdiction.

For details, please contact your local Eclipse representative or Eclipse.

NOTE: Eclipse supports NFPA regulations (two shut-off valves) as a minimum standard for main gas safety shut-off systems.

Step 7: Process Temperature Control System

The process temperature control system is used to control and monitor the temperature of the system. There is a wide variety of control and measuring equipment available.

For details, please contact your Eclipse representative or the Eclipse family.



Appendix

Conversion Factors

Metric to English

From	To	Multiply By
actual cubic meter/h (am ³ /h)	actual cubic foot/h (acfh)	35.31
normal cubic meter/h (Nm ³ /h)	standard cubic foot /h (scfh)	38.04
degrees Celsius (°C)	degrees Fahrenheit (°F)	(°C x 9/5) + 32
kilogram (kg)	pound (lb)	2.205
kilowatt (kW)	Btu/h	3415
meter (m)	foot (ft)	3.281
millibar (mbar)	inches water column ("w.c.)	0.402
millibar (mbar)	pounds/sq in (psi)	14.5 x 10 ⁻³
millimeter (mm)	inch (in)	3.94 x 10 ⁻²
MJ/Nm ³	Btu/ft ³ (standard)	26.86









Metric to Metric

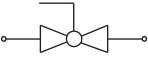

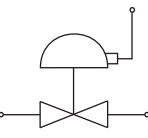
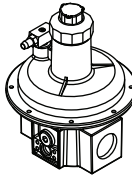

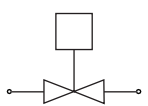
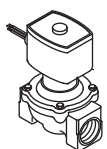

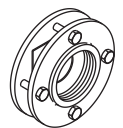

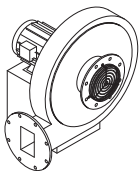
From	To	Multiply By
kiloPascals (kPa)	millibar (mbar)	10
meter (m)	millimeter (mm)	1000
millibar (mbar)	kiloPascals (kPa)	0.1
millimeter (mm)	meter (m)	0.001

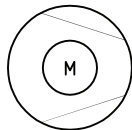
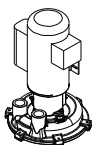
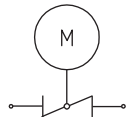
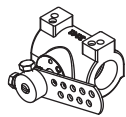
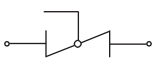
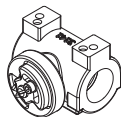
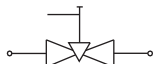
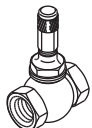
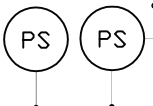
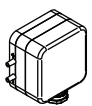
English to Metric

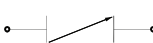
From	To	Multiply By
actual cubic foot/h (acfh)	actual cubic meter/h (am ³ /h)	2.832 x 10 ⁻²
standard cubic foot /h (scfh)	normal cubic meter/h (Nm ³ /h)	2.629 x 10 ⁻²
degrees Fahrenheit (°F)	degrees Celsius (°C)	(°F - 32) x 5/9
pound (lb)	kilogram (kg)	0.454
Btu/h	kilowatt (kW)	0.293 x 10 ⁻³
foot (ft)	meter (m)	0.3048
inches water column ("w.c.)	millibar (mbar)	2.489
pounds/sq in (psi)	millibar (mbar)	68.95
inch (in)	millimeter (mm)	25.4
Btu/ft ³ (standard)	MJ/Nm ³	37.2 x 10 ⁻³

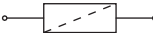
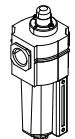
System Schematics

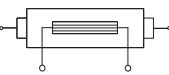
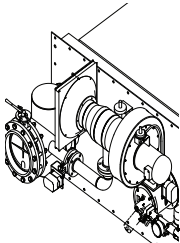
Symbol	Appearance	Name	Remarks	Bulletin/ Info Guide
		Gas Cock	Gas cocks are used to manually shut off the gas supply.	710
		Ratio Regulator	A ratio regulator is used to control the air/gas ratio. The ratio regulator is a sealed unit that adjusts the gas pressure in ratio with the air pressure. To do this, it measures the air pressure with a pressure sensing line, the impulse line. This impulse line is connected between the top of the ratio regulator and the burner body.	
		Main Gas Shut-Off Valve Train	Eclipse strongly endorses NFPA as a minimum.	790/791
		Pilot Gas Valve Train	Eclipse strongly endorses NFPA as a minimum.	790/791
		Automatic Shut-Off Valve	Shut-off valves are used to automatically shut off the gas supply on a gas system or a burner.	760
		Orifice Meter	Orifice meters are used to measure flow.	930
		Combustion Air Blower	The combustion air blower provides the combustion air to the burner(s).	610

Symbol	Appearance	Name	Remarks	Bulletin/ Info Guide
		Hermetic Booster	Booster is used to increase gas pressure.	620
		Automatic Butterfly Valve	Automatic butterfly valves are typically used to set the output of the system.	720
		Manual Butterfly Valve	Manual butterfly valves are used to balance the air or gas flow at each burner.	720
		Adjustable Limiting Orifice	Adjustable limiting orifices are used for fine adjustment of gas flow.	728/730
		Pressure Switch	A switch activated by rise or fall in pressure. A manual reset version requires pushing a button to transfer the contacts when the pressure set point is satisfied.	840
		Pressure Gauge	A device to indicate pressure.	940
		Check Valve	A check valve permits flow only in one direction and is used to prevent back flow of gas.	780
		Strainer	A strainer traps sediment to prevent blockage of sensitive components downstream.	
		Flexible Connector	Flexible connectors isolate components from vibration, mechanical, and thermal stresses.	
		Heat Exchanger	Heat exchangers transfer heat from one medium to another.	500
		Pressure Taps	Pressure taps measure static pressure.	

